

072204 HGDC

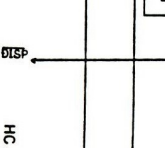

072204 HGDC

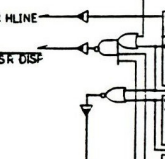

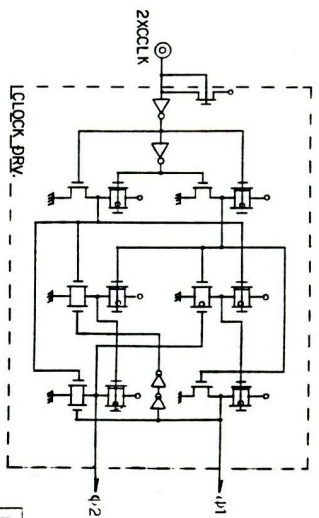
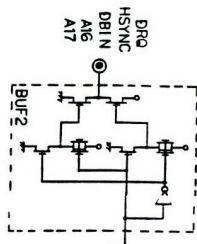
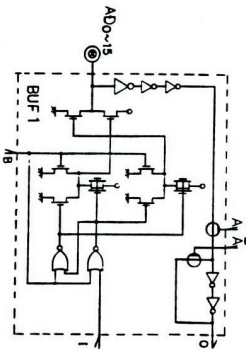
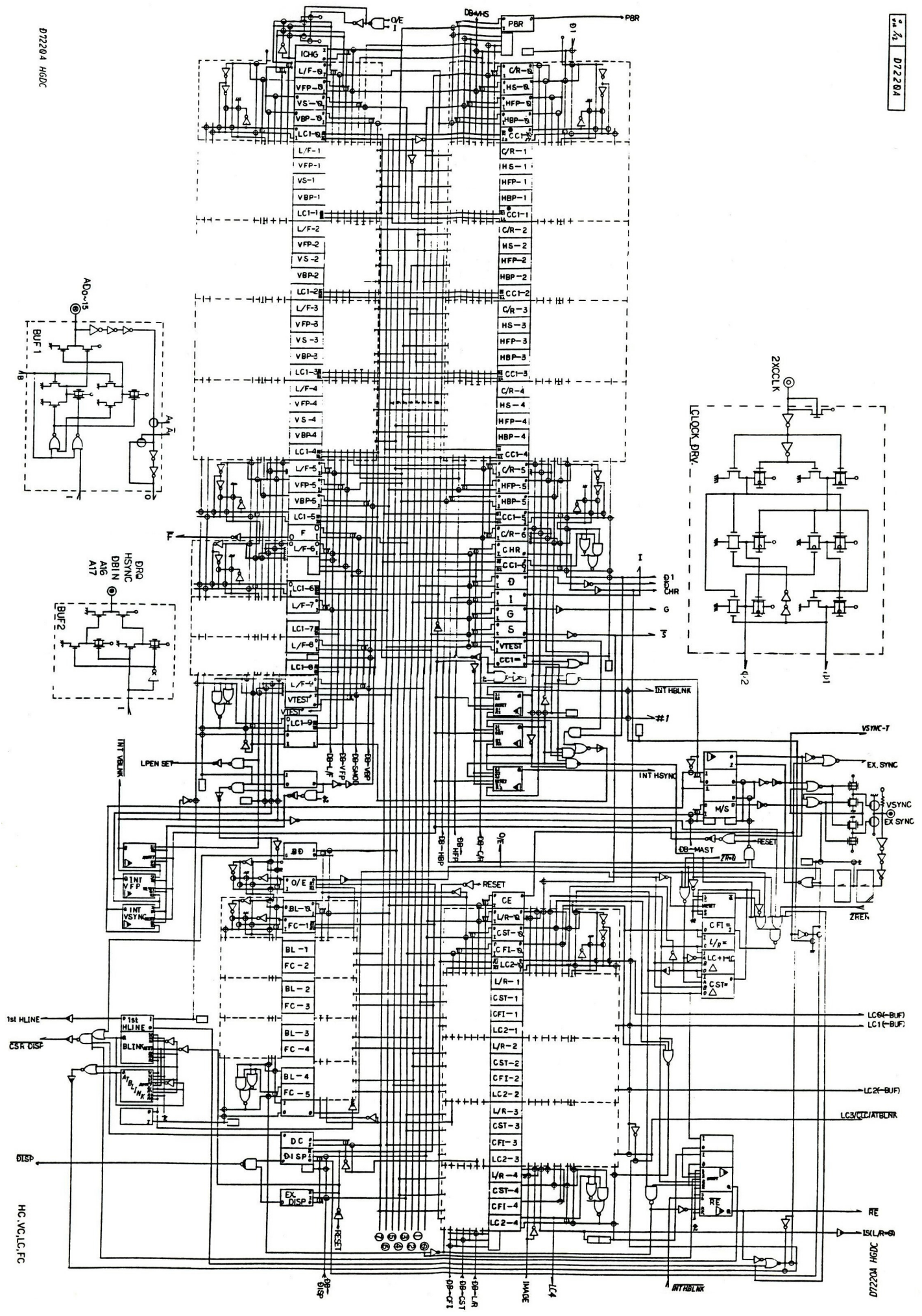
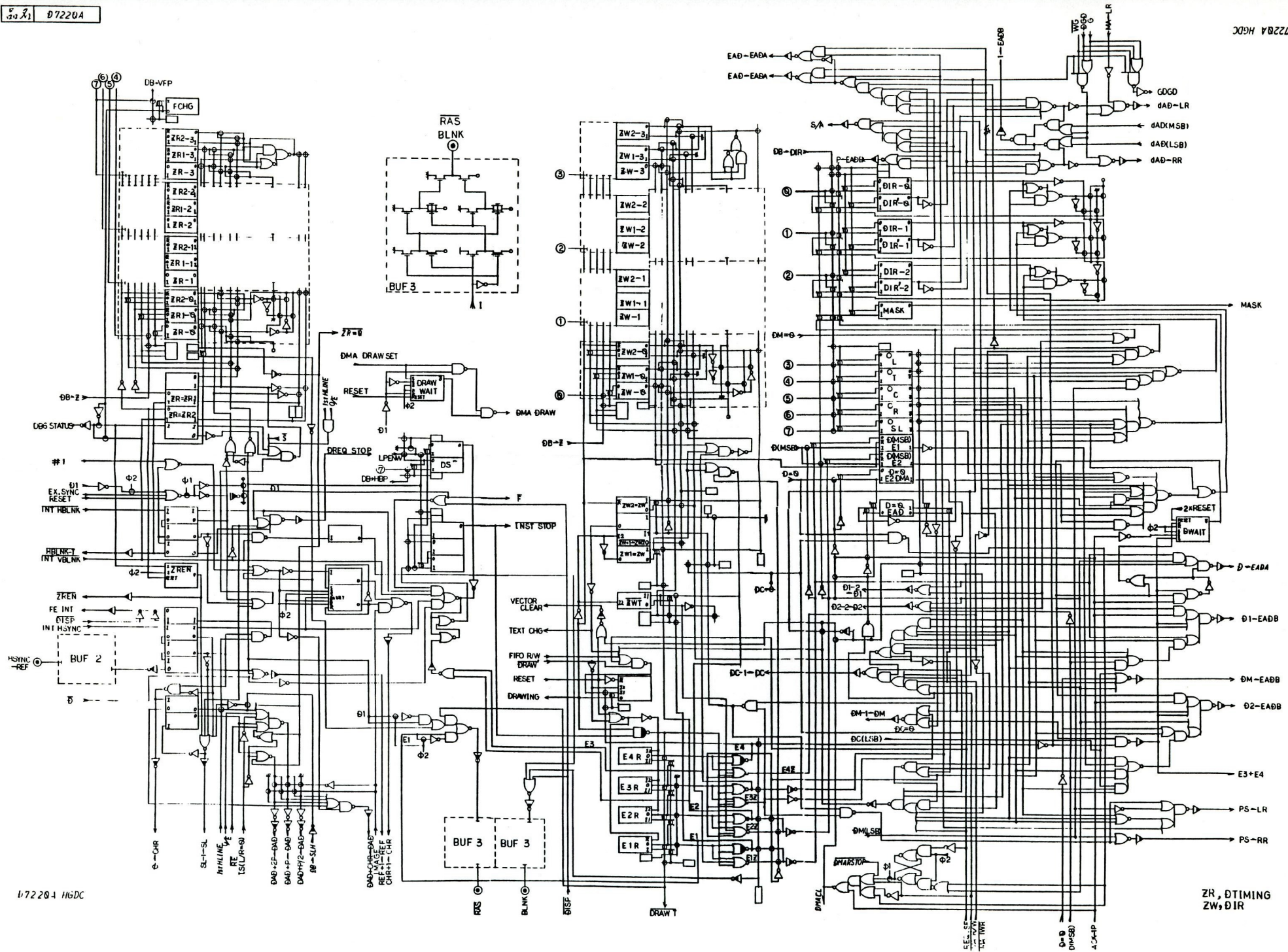
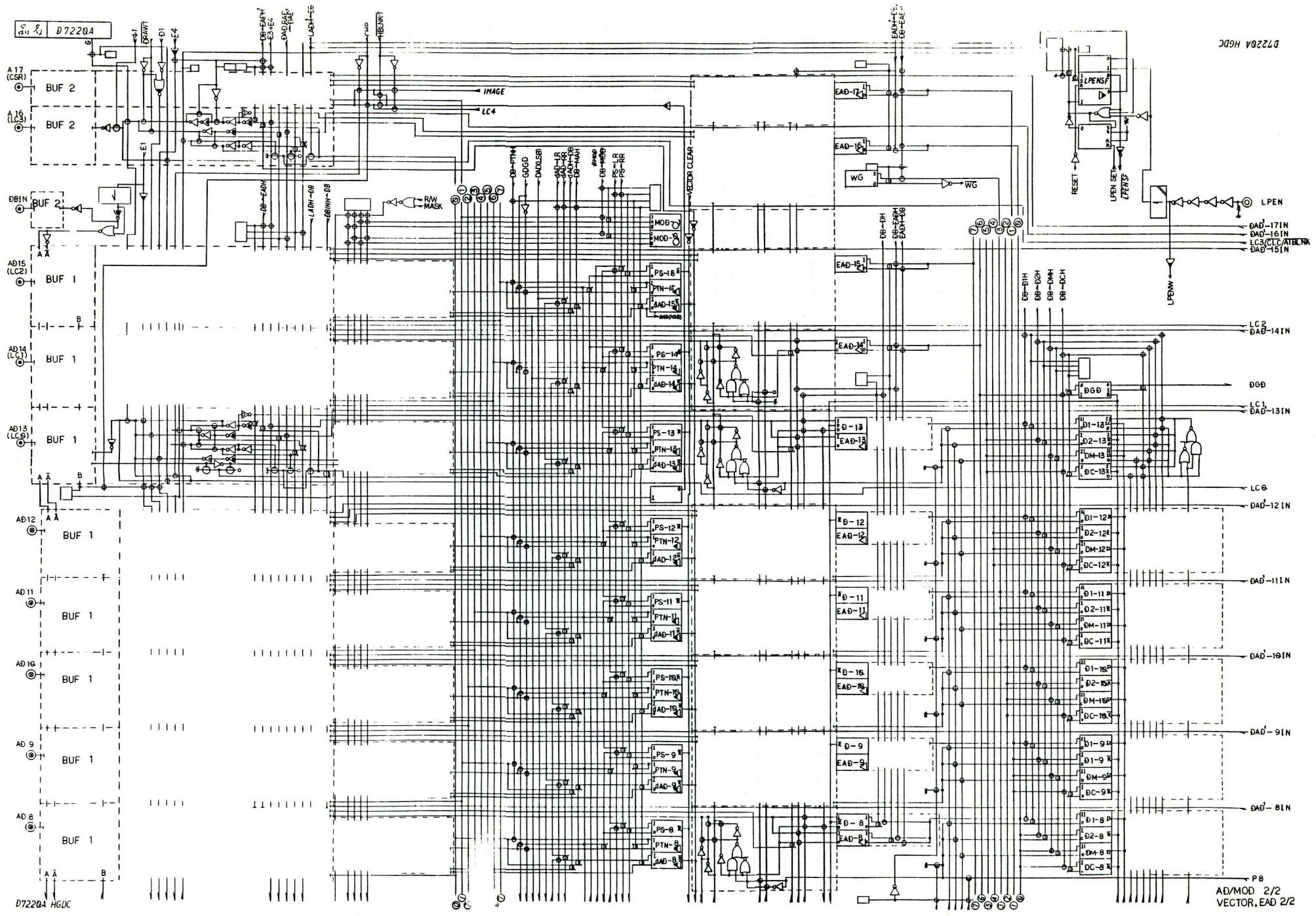

Page layout of μ PD7220A logic schematics

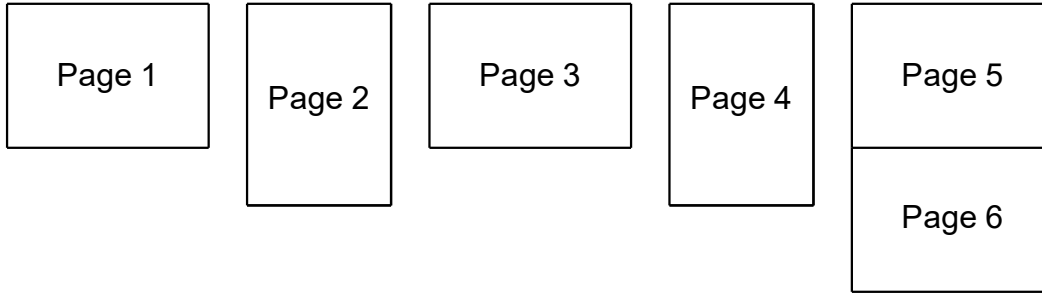

On PDF Viewer,

(1) Maximize window

(2) View – Page Display – Two Page Scrolling

[Die micrograph of \$\mu\$ PD7220A](#) based upon this logic design